

MOORE STORAGE UNITS





#7

W 282 D 25 H 168 cm

Photo: Black oak/Walnut

The design is yours - the possibilities are many

Moore is a range of elaborate and floating shelves and cabinets enabling you to design your own wall combination to your exact requirement.

The cabinets have nicely rounded solid edges with mitre joints and the choice of sliding doors or flaps with fabric.

The wall system is created with a light expression, allowing you to design your unique Moore unit to fit the wall space you have available, and in a variety of combinations, colours and types of wood.





#12
W 220 D 25 H 168 cm
Photo: Oak oil/Oak oil



#9

W 96 D 25 H 72 cm

Photo: Oak oil/Black oak



#10

W 96 D 25 H 168 cm

Photo: Oak oil/Oak oil



#4

W 220 D 25 H 168 cm

Photo: Black oak/Light oak



#1
W 158 D 25 H 120 cm
Photo: Walnut/Walnut

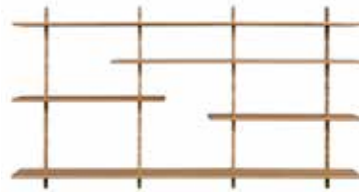

#2
W 220 D 25 H 120 cm
Photo: Oak oil/Oak oil



#3
W 220 D 25 H 120 cm
Photo: Light oak/Light oak



#6
W 220 D 25 H 168 cm
Photo: Walnut/Walnut



#8
W 282 D 25 H 168 cm
Photo: Oak oil/Oak oil

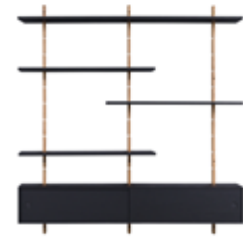

#11
W 158 D 25 H 168 cm
Photo: Oak oil/Black oak



#13
W 220 D 25 H 168 cm
Photo: Black oak/Black oak

Frontpage



#5
W 220 D 25 H 168 cm
Photo: Black oak/Black oak

Max. load

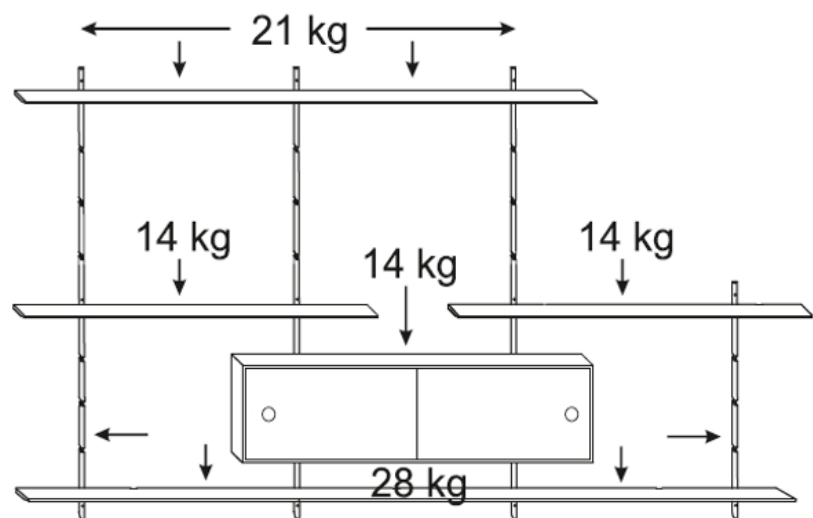



Wall mounted shelving system

168 cm #981026
 120 cm #981024
 72 cm #981022
 48 cm #961021



Shelves for mounting

Weight per. shelf: 14 kg. per 2 rails.
 220 cm #981123
 158 cm #981122
 96 cm #981121



#981221

W 96 D 25 H 26 cm
 Mounted on 2 rails
 With 2 sliding doors



#981222

W 158 D 25 H 26 cm
 Mounted on 3 rails
 With 2 sliding doors



#981231

W 96 D 25 H 14 cm
 Mounted on 2 rails
 With drop down flap in black fabric



#981232

W 158 D 25 H 14 cm
 Mounted on 3 rails
 With drop down flap in black fabric

WOOD



043 Light oak lac



087 Black oak lac

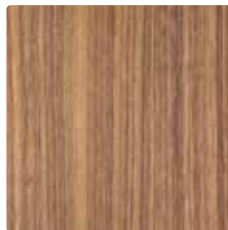

075 Walnut oil

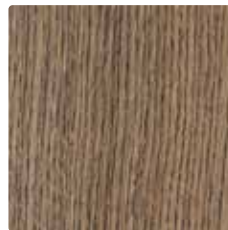

049 Smoked oak oil

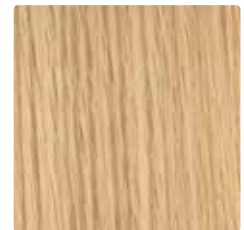

045 Oak natural oil

The Moore minimalistic designed wall unit system consisting of floating shelves, wall units and media units will enable you to design your own wall unit combination to your exact requirement. All shelves and wall/media units comes with nicely rounded solid edges with mitre joints with a choice of wooden sliding doors and fabric clad flaps through which the signals from your remote control will easily pass enabling you to operate your various AV-appliances. Moore gives you the unique opportunity to design your own storage or display unit perfect for your home.



designed by Michael H. Nielsen

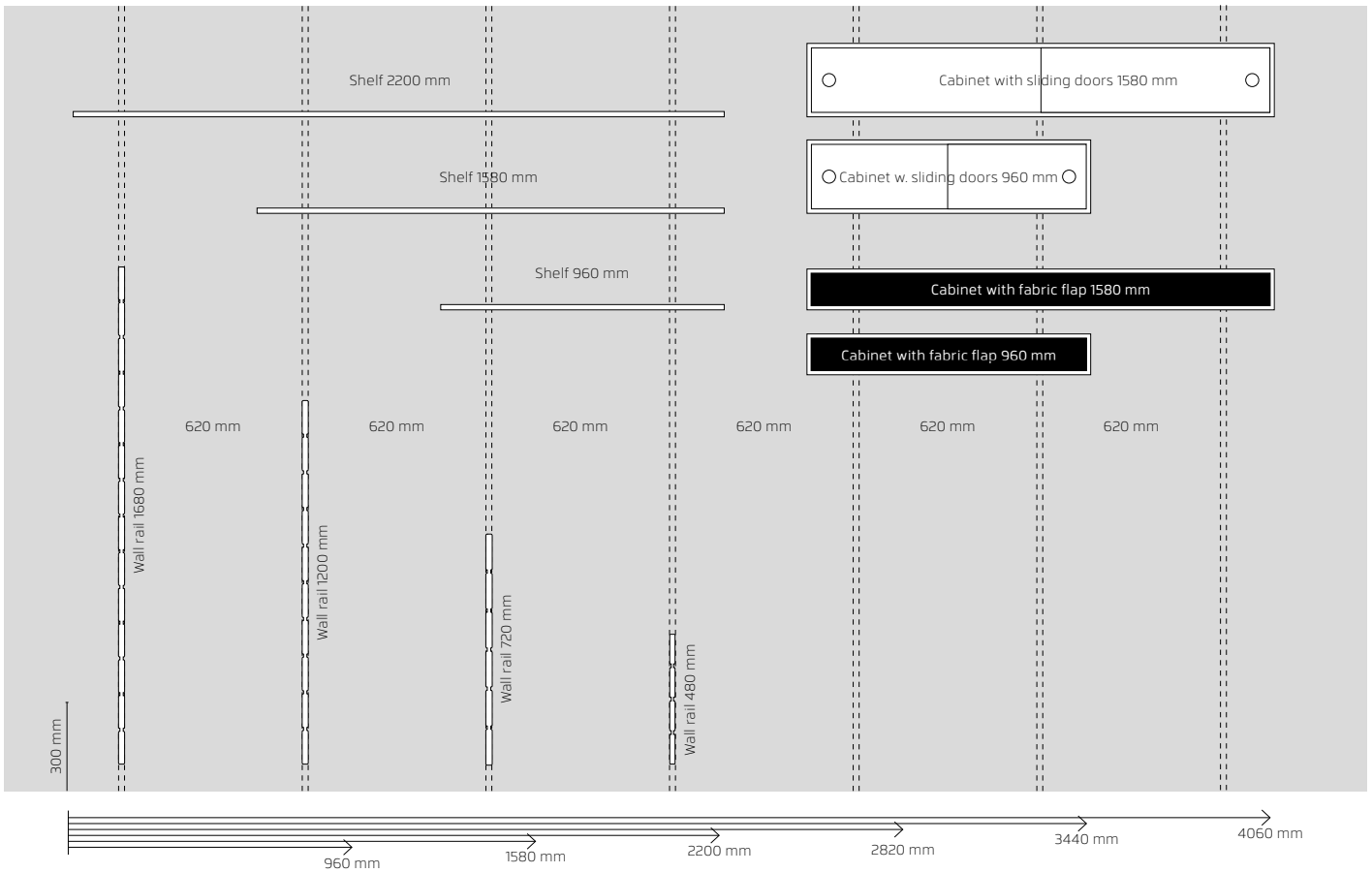

DESIGN YOUR OWN

Play with shelves, cabinets and wall rails to design your own Moore storage unit.

