

MOORE STORAGE UNITS



MOORE The rack shelves are designed to be minimal and simplistic, and to display your curious findings. Moore is created using less materials and keeping it simple. With wooden floating shelves that creates a sense of openness and cabinets made with mitre joints and sliding doors or black fabric flap for media units. Moore gives you the unique opportunity to design your own storage or display unit perfect for your home.

www.pbjdesignhouse.com

*Designed by
Michael H Nielsen*

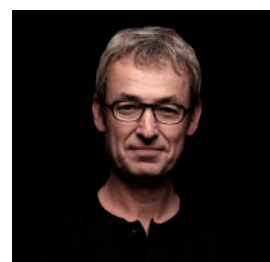

MOORE INSPIRATION



Moore no 981575-01
W 96 D 25 H 72 cm
Walnut/Walnut



Moore no 981575-02
W 158 D 25 H 120 cm
Walnut/Walnut

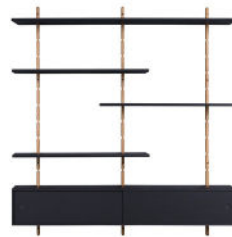

Moore no 981587-03
W 158 D 25 H 168 cm
Oak oil/Black oak



Moore no 981575-04
W 220 D 25 H 168 cm
Walnut/Walnut

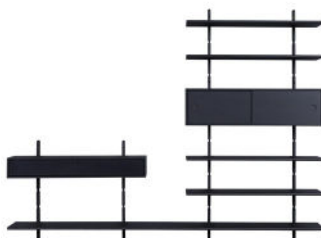

Moore no 981587-05
W 220 D 25 H 168 cm
Black oak/Black oak

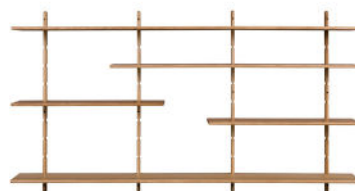

Moore no 981545-06
W 220 D 25 H 120 cm
Oak oil/Oak oil



Moore no 981543-07
W 220 D 25 H 120 cm
Light oak/Light oak

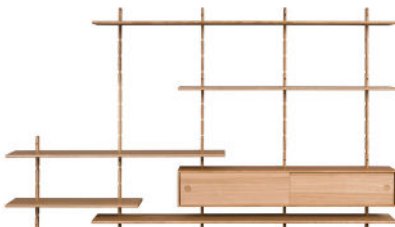

Moore no 981545-08
W 282 D 25 H 168 cm
Oak oil/Oak oil



Moore no 981545-09
W 220 D 25 H 168 cm
Oak oil/Oak oil



Wall mounted shelving system

168 cm no 981026
 120 cm no 981024
 72 cm no 981022
 48 cm no 961021



Shelves for mounting

Weight per. shelf: 14 kg. per 2 rails.
 220 cm no 981123
 158 cm no 981122
 96 cm no 981121



Cabinet no 981221

W 96 D 25 H 26 cm
 Mounted on 2 rails
 With 2 sliding doors



Cabinet no 981222

W 158 D 25 H 26 cm
 Mounted on 3 rails
 With 2 sliding doors



Cabinet no 981224

W 96 D 25 H 14 cm
 Mounted on 2 rails
 With drop down flap in black fabric



Cabinet no 981231

W 158 D 25 H 14 cm
 Mounted on 3 rails
 With drop down flap in black fabric

COLOURS

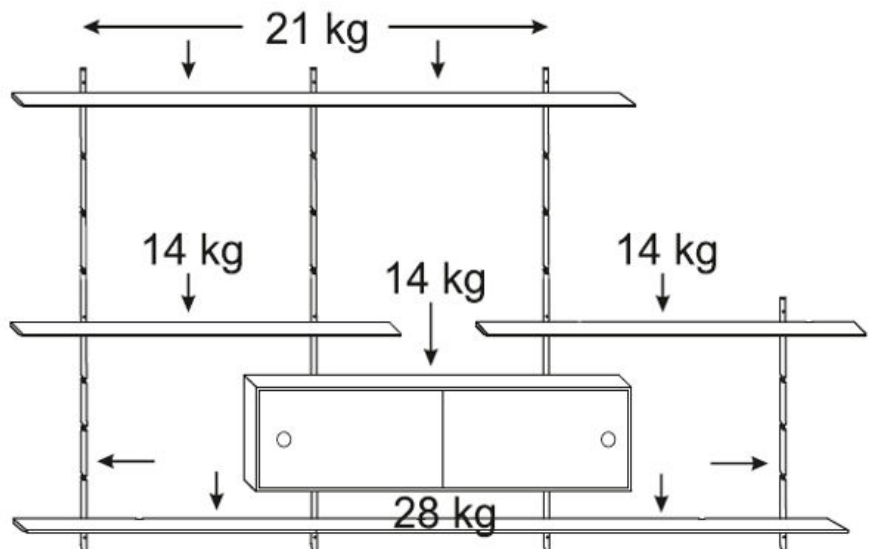
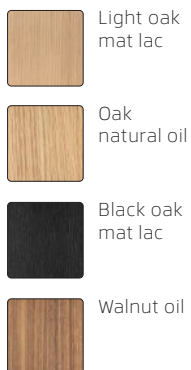

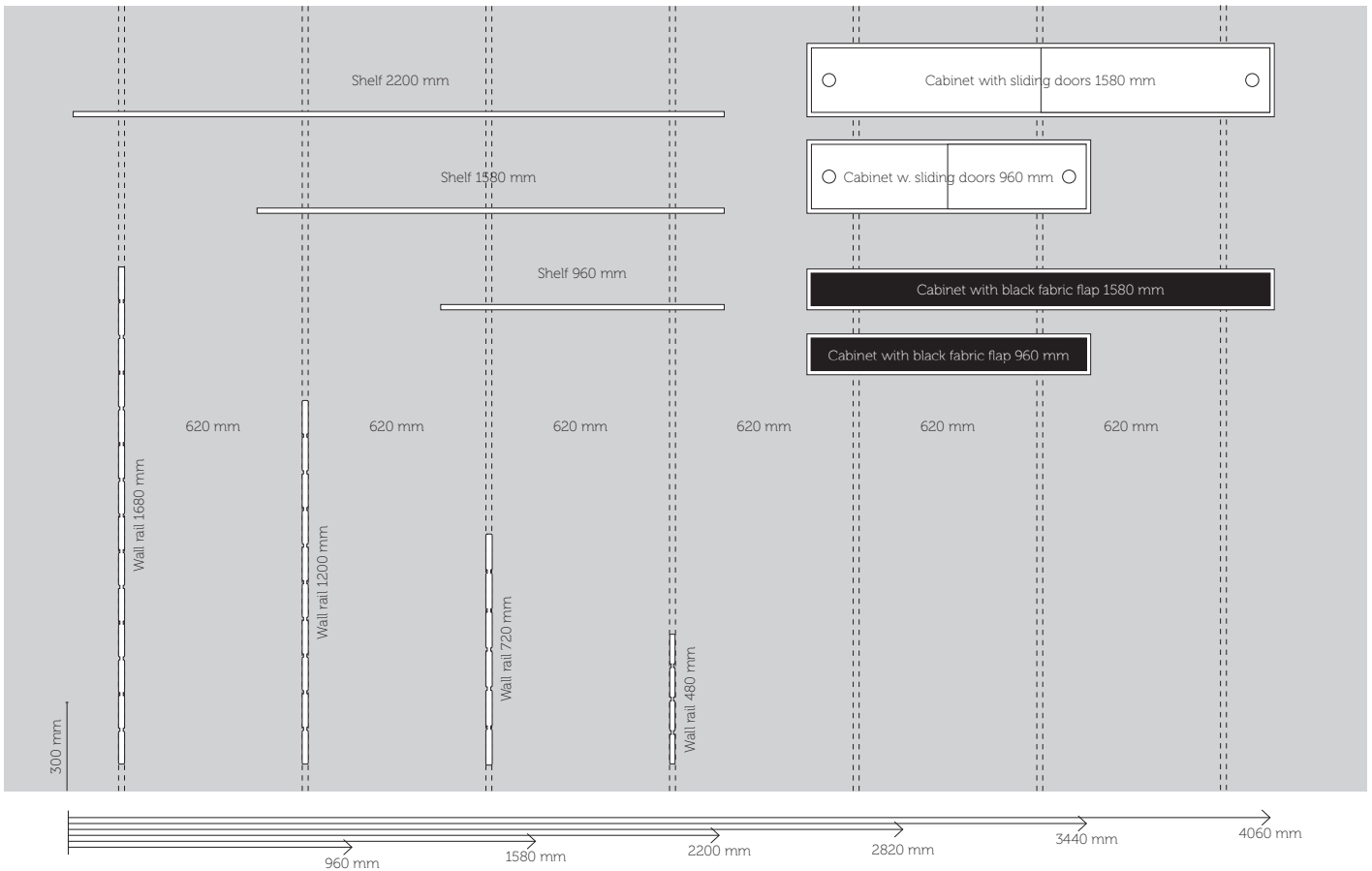

DESIGN YOUR OWN

Play with shelves, cabinets and wall rails to design your own Moore storage unit.

